



il tuo specchio d'acqua / your own pool

Classic - Pop! - Playa - Dolcevita - Divina - Bluespring

PISCINE
LAGHETTO[®]

pool design



il tuo specchio d'acqua / your own pool

Classic

PISCINE
LAGHETTO®

Classic

LA CLASSICA LAGHETTO

Classic è la linea di piscine fuori terra da decenni rappresenta la storia della piscina fuori terra e del marchio Piscine Laghetto, grazie all'ineguagliabile mix di qualità, durata ed affidabilità.

Classic è continuità nella tradizione Piscine Laghetto, fatta di piscine made in Italy, frutto di una continua evoluzione e di oltre 40 anni di ricerca, esperienza ed innovazione che ne permettono l'utilizzo nella più ampia varietà di contesti e condizioni.

THE CLASSIC LAGHETTO

Classic is the line of above ground pools that for decades has represented the history of the above ground pool and of the Piscine Laghetto brand, thanks to the unrivalled mix of quality, durability and reliability.

Classic is continuity in the Piscine Laghetto tradition, made up of made in Italy swimming pools, the result of unceasing evolution and over 40 years of research, experience and innovation that allow those pools to be used in the widest variety of contexts and conditions..

LA LAGHETTO CLASSIQUE

Classic est la gamme de piscines hors sol qui, depuis des décennies, représente l'histoire de la piscine hors sol et de la marque Laghetto, grâce à un mélange inégalé de qualité, durabilité et fiabilité.

Classic est une continuité dans la tradition Laghetto, composée de piscines made in Italy, le résultat d'une évolution continue et de plus de 40 ans de recherche, d'expérience et d'innovation qui lui permettent d'être utilisé dans la plus grande variété de contextes et de conditions.



Classic

CARATTERISTICHE TECNICHE

- > Tessuto telo vasca in poliestere con spalmatura PVC ad alta impermeabilità.
- > Skimmer brevettato Laghetto performante a 360 gradi.
- > Tubazioni e raccordi in PVC ad alta resistenza.
- > Scala di sicurezza.
- > Speciali blocchi di appoggio per il montaggio su prato (sottopiedi)
- > Impianti di filtrazione e trattamento acqua esclusivi Laghetto.
- > Kit aspirafango per la pulizia del fondo.



TECHNICAL FEATURES

- > High impermeability PVC coated high strength pool membrane
- > Patented Laghetto skimmer with 360 degrees performance
- > Heavy duty PVC pipes and fitting
- > Safety ladder
- > Exclusive Laghetto filtration systems
- > Foot blocks for assembly on unpaved surfaces
- > Vacuum cleaner

CARACTERISTIQUES TECHNIQUES

- > Toile bassin en polyester avec trame en PVC armé à haute imperméabilité
- > Skimmer breveté Laghetto performant à 360°
- > Tuyaux et raccords en PVC haute résistance
- > Échelle de sécurité
- > Systèmes de filtration et de traitement de l'eau propres à Laghetto
- > Blocs d'appui spéciaux pour installation sur gazon
- > Aspirateur de fond



MOD.	SPECCHIO D'ACQUA water size miroir d'eau (m)	ALTEZZA ACQUA water height hauteur de l'eau (m)	INGOMBRO TOTALE* total encumbrance encombrement total (m)	VOLUME (mc)
24	2,80 x 4,00	1,2	3,84 x 5,04	13,5
25	2,80 x 5,30	1,2	3,84 x 6,34	17
26	2,80 x 6,60	1,2	3,84 x 7,64	21,5
27	2,80 x 7,80	1,2	3,84 x 8,84	25
47	4,00 x 7,80	1,2	5,04 x 8,84	36

* Ingombro totale della piscina comprensivo di sottopiedi. * Overall dimensions of the pool including foot blocks. * Encombrement total de la piscine avec cales sous pieds incluses.

Classic

3 | *years*
WARRANTY

GARANZIA PISCINA: 3 ANNI
POOL WARRANTY: 3 YEARS | GARANTIE BASSIN: 3 ANS
GARANZIA ACCESSORI: 2 ANNI
ACCESSORIES WARRANTY: 2 YEARS | GARANTIE ACCESSOIRES: 2 ANS

Designed and made in Italy.

Friendly materials according to the European standards of safety and non-toxicity.

Laghetto quality, leader for 40 years.



CLASSIC PROFESSIONAL

La tecnologia **Classic Professional** Piscine Laghetto viene utilizzata in tutto il mondo dagli organizzatori di eventi per la produzione di piscine di grandi dimensioni, pronte in poche ore, straordinariamente solide, adatte a resistere agli utilizzi più disparati.

La capacità progettuale del nostro team di ricerca e sviluppo è tale da soddisfare ogni richiesta da parte del committente.

Classic Professional è disponibile con misure personalizzabili a partire da 7,5 x 15 m.



CLASSIC PROFESSIONAL

The technology of Laghetto **Professional Classic** is also the base for the production of large pools that are used worldwide by event organizers that need a pool ready in a few hours, extraordinarily strong, suitable to resist the many different situations.

The design capacity of our research and development team is able to satisfy every request from the customer.

Classic Professional is available in customisable sizes from 7.5 x 15 m.

CLASSIC PROFESSIONAL

La technologie **Classic Professional** Piscine Laghetto est utilisée dans le monde entier par les organisateurs d'événements à la recherche de piscines de grandes dimensions, opérationnelles en quelques heures, extraordinairement robustes et capables de résister aux utilisations les plus disparates.

La capacité de notre bureau d'étude à imaginer et développer de nouveaux projets est telle que nous pouvons satisfaire la demande de chaque client.

Classic Professional est disponible dans des mesures personnalisables à partir de 7,5 x 15 m.



pool design



il tuo specchio d'acqua / your own pool

POP!

**PISCINE
LAGHETTO®**

POP!

UN TUFFO NEL COLORE

POP!

è un progetto innovativo
nel panorama mondiale
delle piscine fuori terra.

Frutto dell'inconfondibile design italiano,
POP! è stata creata per immergersi
in un sogno colorato ad allegro come
Alice nel Paese delle Meraviglie.

Le curve soffici e tondeggianti,
la vivacità della forma,
le nuances dai nomi fiabeschi
rimandano ad un cartone animato
e regalano al giardino una pennellata
di vivacità e freschezza.

A DIP INTO THE COLORS

POP!

is an innovative design for the global above-ground pool market.

Product of the unmistakable Italian design,
POP! is your gate for a splash in the Alice merry wonderland.

The soft and rounded curves of the liveliness form,
the nuances fairytale names evoke a cartoon
and give the garden a touch of vivacity and freshness.

UN PLONGEON COLORÉ

POP!

est un projet mondialement innovant en matière de piscines hors sol.

Fruit de l'inimitable design à l'italienne,
POP! a été inventée pour pouvoir se plonger dans un songe coloré
et joyeux tel Alice au pays des merveilles.

Les courbes délicates et arrondies, la vivacité de sa forme,
les divers coloris aux noms enchanteurs,
renvoient aux dessins animés de notre enfance
et offrent au jardin une touche de gaieté et de fraîcheur.







POP!

PISCINE **LAGHETTO**®



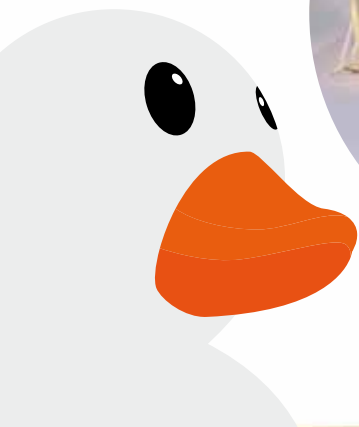
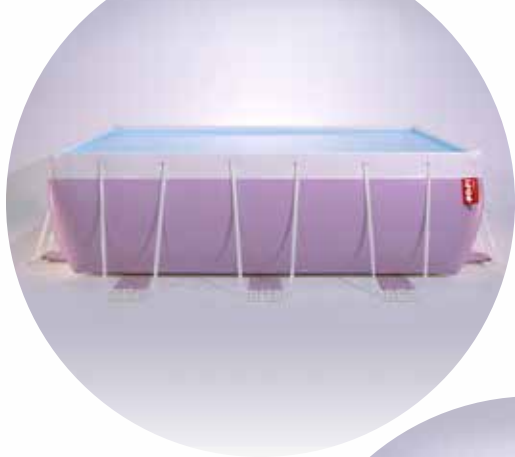

2022
popi



 **LILLA FARFALLA**
butterfly lilac
lilas papillon

 **VERDE BRUCO**
caterpillar green
vert chenille

 **SABBIA DI MARE**
sea sand
sable de plage

 **BLU LAGHETTO**
Laghetto blue
bleu Laghetto



DOTAZIONI DI SERIE

- > Faretto a Led
- > Scala di sicurezza
- > Impianto di filtrazione e trattamento acqua esclusivo Laghetto
- > Speciali blocchi di appoggio per il montaggio su prato

EQUIPMENT

- > LED spot light > Safety ladder
- > Laghetto exclusive filtration system and water treatment
- > Special foot support for ground assembling

EQUIPEMENT

- > Projecteur à Led > Échelle de sécurité
- > Système de filtration et de traitement exclusifs Laghetto
- > Cales sous pieds spécialement conçues pour montage sur gazon

pop!

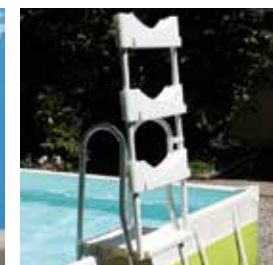

MOD.	COLORE DISPONIBILE colour available couleur disponible	SPECCHIO D'ACQUA (m) water size miroir d'eau	ALTEZZA ACQUA (m) water height hauteur de l'eau	INGOMBRO TOTALE (m) total encumbrance encombrement total	VOLUME (mc)
24	● ● ●	2,80 x 4,00	1,2	3,84 x 5,04	13,5
25	● ● ●	2,80 x 5,30	1,2	3,84 x 6,34	17
26	● ● ●	2,80 x 6,60	1,2	3,84 x 7,64	21,5
27	● ● ●	2,80 x 7,80	1,2	3,84 x 8,84	25
46	● ● ●	4,00 x 6,60	1,2	5,04 x 7,64	30,5
47	● ● ●	4,00 x 7,80	1,2	5,04 x 8,84	36
49	● ● ● ●	4,00 x 9,00	1,2	5,04 x 10,04	41,5
510	● ● ● ●	5,30 x 10,25	1,2	6,34 x 11,29	62,5
511	● ● ● ●	5,30 x 11,50	1,2	6,34 x 12,54	70
612	● ● ● ●	6,60 x 12,70	1,2	7,64 x 13,74	96,5

pop!

5 1/2 years
WARRANTY

GARANZIA PISCINA: 5 ANNI
POOL WARRANTY: 5 YEARS | GARANTIE BASSIN: 5 ANS
GARANZIA ACCESSORI: 2 ANNI
ACCESSORIES WARRANTY: 2 YEARS | GARANTIE ACCESSOIRES: 2 ANS

Designed and made in Italy.

Friendly materials according to the European standards of safety and non-toxicity.

Laghetto quality, leader for 40 years.

pool design

2022
NEWS



il tuo specchio d'acqua / your own pool

CRYSTAL
POP!

PISCINE
LAGHETTO®

CRYSTAL POP!

LA TRASPARENZA È DI MODA

Crystal Pop è la nuova nata della famiglia Pop! e ne condivide l'attitudine fashion oltre che i dettagli e le caratteristiche tecniche.

Il "tocco in più" è la trasparenza che attraverso un gioco di finestrature e la luce interna rendono Crystal pop bellissima sia di giorno che di notte.



TRANSPARENCY IS FASHION

Crystal Pop is the newest member of the Pop! family and shares its fashion attitude as well as its details and technical features.

The "extra touch" is the transparency that makes Crystal Pop beautiful both day and night through a play of windows and internal light.

LA TRANSPARENCE EST À LA MODE

Crystal Pop est le dernier membre de la famille Pop! et partage son attitude mode ainsi que ses détails et caractéristiques techniques.

La "touche supplémentaire" est la transparence qui, par un jeu de fenêtres et de lumière intérieure, rend Crystal Pop magnifique de jour comme de nuit.



Day & Night



COLORI > COLOURS > COULEURS



crystal - white



crystal - sand



CRYSTAL
popi

DOTAZIONI DI SERIE

- > Faretto a Led
- > Scala di sicurezza
- > Impianto di filtrazione e trattamento acqua esclusivo Laghetto
- > Speciali blocchi di appoggio per il montaggio su prato



EQUIPMENT

- > LED spot light
- > Safety ladder
- > Laghetto exclusive filtration system and water treatment
- > Special foot support for ground assembling

EQUIPEMENT

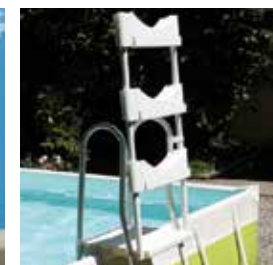
- > Projecteur à Led
- > Échelle de sécurité
- > Système de filtration et de traitement exclusifs Laghetto
- > Cales sous pieds spécialement conçues pour montage sur gazon



MOD.	COLORI DISPONIBILI 2022 available colours couleurs disponibles	SPECCHIO D'ACQUA water size miroir d'eau (m)	ALTEZZA ACQUA water height hauteur de l'eau (m)	DIMENSIONI TOTALI total encumbrance encombrement total (m)	VOLUME (mc)
24		2,80 x 4,00	1,20	3,84 x 5,04	13,5
25		2,80 x 5,30	1,20	3,84 x 6,34	17

misure indicative (non vincolanti)
 the measures are indicatives dimensions indicatives

CRYSTAL
popi

3/² years
WARRANTY

GARANZIA PISCINA: 3 ANNI
 POOL WARRANTY: 3 YEARS | GARANTIE BASSIN: 3 ANS
GARANZIA ACCESSORI: 2 ANNI
 ACCESSORIES WARRANTY: 2 YEARS | GARANTIE ACCESSOIRES: 2 ANS

Designed and made in Italy.

Friendly materials according to the European standards of safety and non-toxicity.

Laghetto quality, leader for 40 years.

pool design



il tuo specchio d'acqua / your own pool

PLAYA

PISCINE
LAGHETTO[®]

PLAYA

UN SALOTTO D'ACQUA

Playa è una minipiscina elegantissima nata dal grande design italiano.

Il dolce massaggio, l'acqua riscaldata, la piacevolezza delle fibre tessute a mano, invitano a soggiornarvi a lungo in totale benessere e permettono di goderla sia all'interno che all'esterno dell'abitazione.

È raffinata e modulabile, perfetta per una terrazza, in giardino diventa oggetto d'arredo e in casa vero salotto d'acqua.

Con le sue morbide aree prendisole e con la piacevolezza delle fibre tessute a mano, Playa è totalmente personalizzabile, dal lettino prendisole ai pannelli esterni di rattan intrecciato Laghetto white, grey o coffee.

A WATER LOUNGE

Playa is an elegant mini-pool created from the great Italian design.

The gentle hydromassage, the heated water, the pleasantness of the hand woven fibers, invite you to relax in total wellness and allow you to enjoy it both indoors and outside the house.

It's sophisticated and adaptable, perfect for a terrace or a deck, in the garden, it becomes a piece of furniture and in the house a real water lounge.

With its soft sunbathing areas, the submergible cushions, and the pleasantness of the hand woven fabrics, Playa is completely customizable, from the sunbed area to the wicker exterior panels woven available in Laghetto white, grey or coffee.

UN ESPACE BIEN-ETRE

Reflet du Design à l'italienne, **Playa** est une mini piscine élégante.

La douceur de l'hydromassage, l'eau chaude, la finesse des fibres tissées main de ses panneaux, invitent à la détente en intérieur comme en extérieur.

Raffinée et modulable, Playa s'intègre parfaitement sur une terrasse. Dans le jardin ou la maison, elle est un objet de décoration & de bien-être.

Avec un espace dédié au bronzage et des panneaux de fibres tissés main, Playa est complètement personnalisable: choix du coloris des bains de soleil mais aussi, des panneaux d'habillage extérieurs en rattan tressé blanc Laghetto, gris ou "café".



PLAYA 2 - Laghetto white



PLAYA 2 - Coffee

PLAYA

PISCINE LAGHETTO®



PLAYA 2 - Laghetto white

PLAYA LIVING

LIVING PLAYA !

Playa Living è il sogno di coloro che amano vivere a contatto con l'acqua, godendo del piacere della sua vicinanza in ogni ora del giorno.

Prendisole nella pace della mattina, bagno scatenato dei bambini al pomeriggio, relax dell'aperitivo al tramonto, luogo di conversazione la sera.

Evoluzione del modello Playa, con i suoi morbidi cuscini modulabili, Playa Living diventa un'oasi di relax, un vero "salotto" elegante che arreda l'interno della casa o gli spazi esterni.

Playa Living si installa facilmente anche in terrazza perché, componibile, può essere caricata in ascensore. Si riempie in solo due ore.

Playa Living permette di sentirsi a proprio agio con l'acqua, in fantasia e libertà.

LIVING PLAYA !

Playa Living is the dream of those who love to live in contact with the water, enjoying the pleasure of its closeness in every hour of the day.

Place where sunbathing in the peace of the morning, place where children have fun in the afternoon, place where you can relax with a drink at sunset, place for conversation in the evening.

Playa Living is the evolution of Playa model with its soft cushions; it becomes a relaxing oasis, a real "lounge" that decorates the interior of the house or outdoor spaces.

Playa Living is easily installed, even on the terrace, because it is modular and can be loaded into the elevator. It can be filled in just two hours.

Playa Living allows you to feel comfortable with the water, in fantasy and freedom.

LIVING PLAYA !

Playa Living satisfera pleinement les amoureux de l'eau !

Un espace pour profiter du soleil le matin, où les enfants s'amuse l'après-midi, pour se détendre le soir avec un verre de vin en profitant du coucher du soleil ou encore, pour simplement discuter agréablement en soirée.

Playa Living est l'évolution du modèle Playa avec l'intégration de sofa. Playa Living devient alors non seulement un espace de bien-être mais aussi, de relaxation avec un espace "salon" élégant qui valorisera vos espaces intérieurs et extérieurs.

Playa Living s'intégrera parfaitement à une terrasse. Complètement démontable, elle est facile à manipuler et à transporter. Et ce n'est pas tout ! En 2 heures seulement, elle sera remplie d'eau.

Playa Living, c'est l'opportunité de profiter en toute liberté d'une mini-piscine unique !

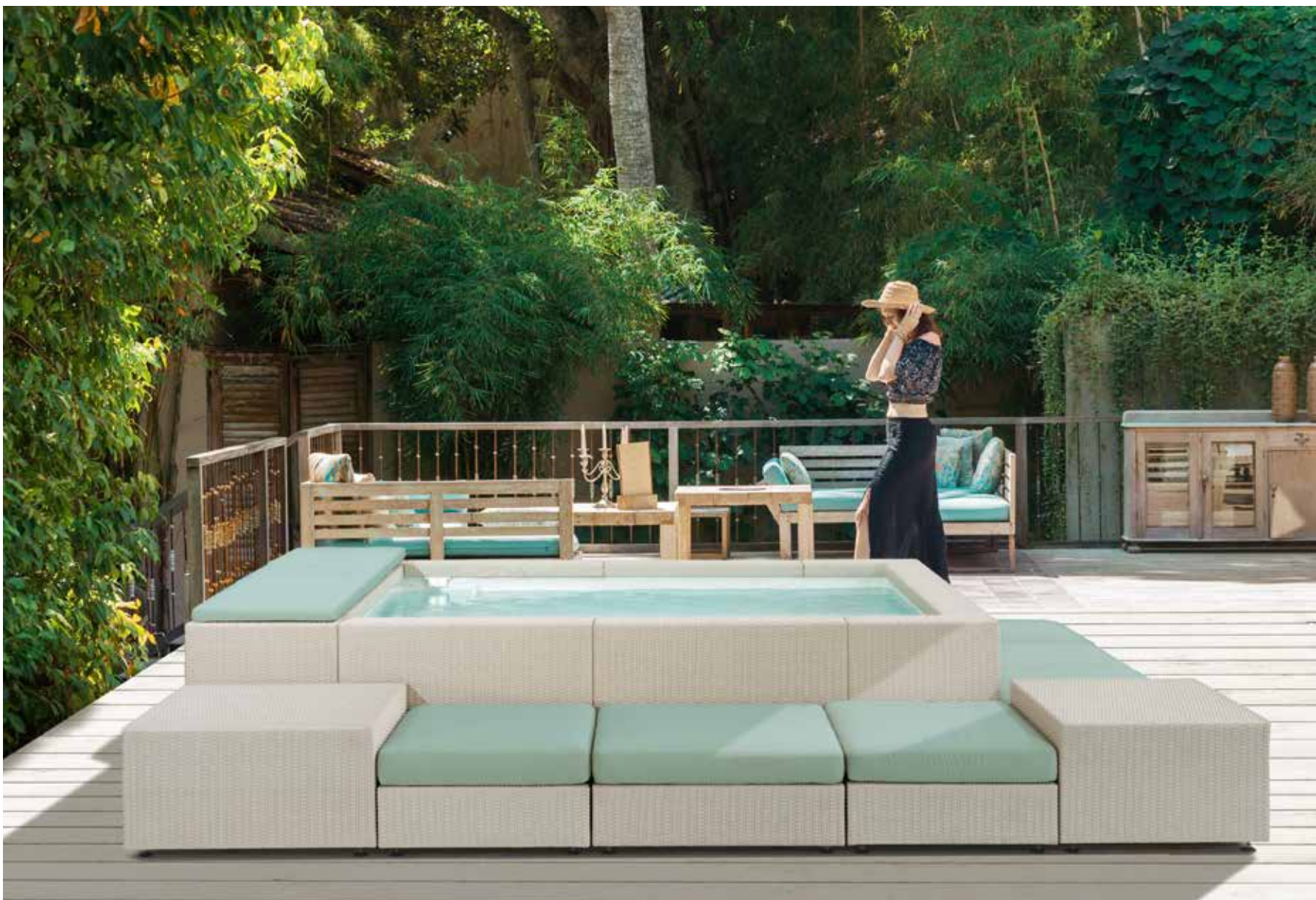

PLAYA 2 LIVING - Laghetto white



PLAYA 3 LIVING - Coffee

PLAYA LIVING

PISCINE LAGHETTO®



PLAYA 2 LIVING - Laghetto white



PLAYA 1 LIVING - Coffee

PLAYA LIVING

PISCINE LAGHETTO®



PLAYA 3 LIVING - Grey

PLAYA

PLAYA LIVING

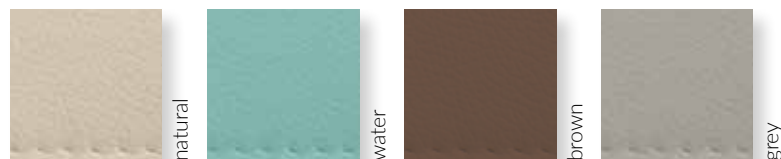

Cuscino Playa
rivestimento in tessuto Sky nautico
disponibile in vari colori

Playa cushion
Nautical Sky fabric finish
available in several colors.

Coussin Playa
Revêtu de tissu Sky nautique
disponible en plusieurs coloris.

Sistemi di filtraggio e **trattamento acqua**
esclusivo Laghetto

Laghetto exclusive **filtration system**
and water treatment

Systèmes de filtration et de traitement
de l'eau exclusifs Laghetto



Pulsanti
per accensione Led
e bolle
(Playa v. Riscaldatore e bolle)

Buttons
for Led light and blower
(Playa v. Hydro & heater)

Boutons
pour projecteur à Led et
blower (Hydromassage et
réchauffeur)

Faretto a Led
faretto ad alta resa luminosa

LED spotlight
high brightness spotlight

Projecteur à Led
luminosité intense



white

Rivestimento interno
Liner
Revêtement intérieur

Pannelli esterni
fibra sintetica intrecciata

Exterior pannels
handwoven fiber

Panneaux extérieurs
Fibre synthétique tressée

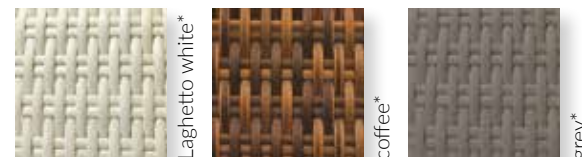

* **ATTENZIONE: Le gradazioni di colore potrebbero subire variazioni.**
ATTENTION : Colour shades may vary.
ATTENTION : Les nuances de couleurs peuvent varier.

PLAYA LIVING

DIMENSIONI DISPONIBILI (cm.) AVAILABLE SIZES DIMENSIONS DISPONIBLES

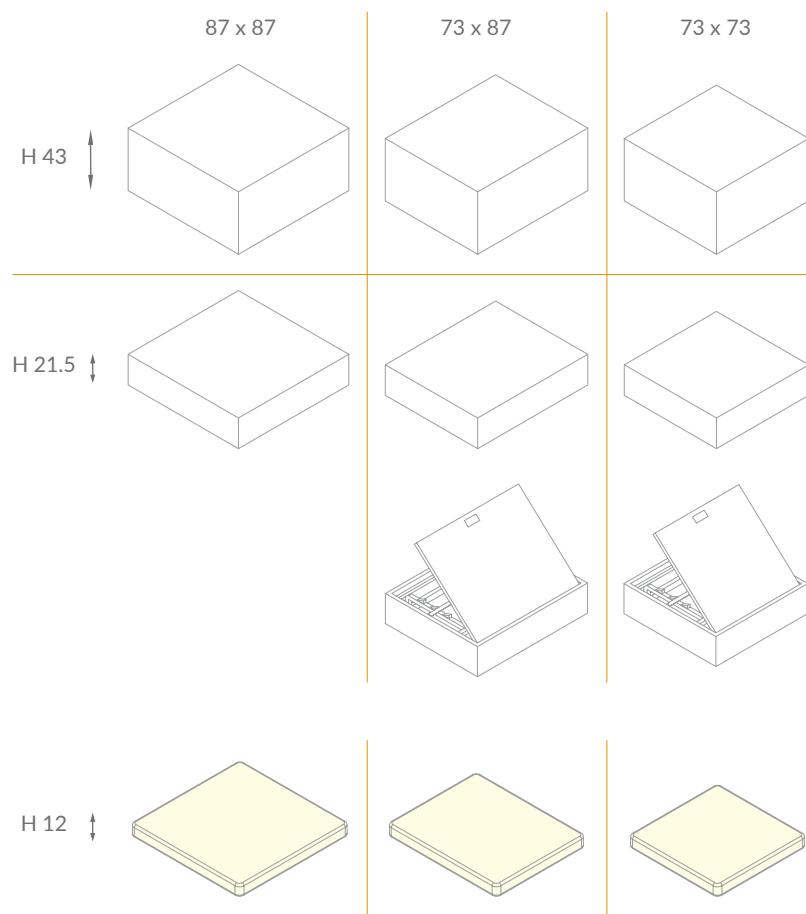

COLORI DISPONIBILI AVAILABLE COLORS COLORIS DISPONIBLES

Fibra sintetica intrecciata

handwoven fiber | Fibre synthétique tressée

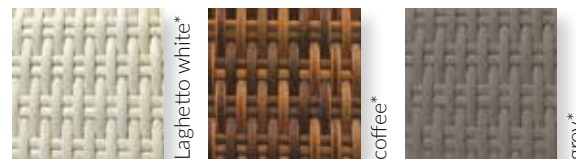

Elemento di seduta Living con schienale inclinabile in quattro posizioni.

Living Seat element with four positions reclinable backrest.
Élément d'assise Living avec dossier inclinable quatre positions.

Cuscini Living in tessuto Sky nautico

Living Nautical Sky fabric cushions | Coussins Living en tissus Sky nautique

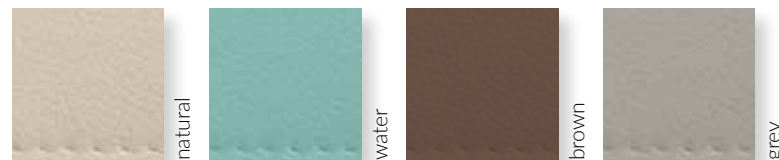

ESEMPI DI COMPOSIZIONE CONFIGURATIONS EXEMPLES EXEMPLES D'AGENCEMENT

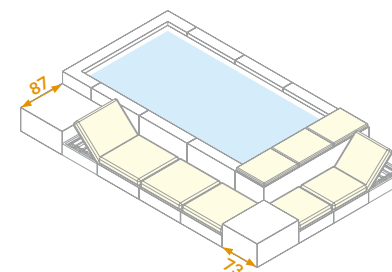
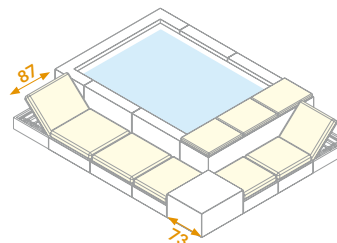
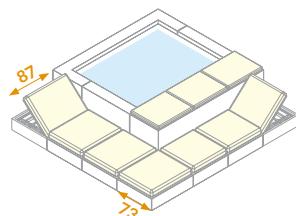
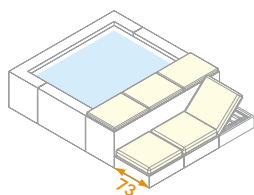

PLAYA

PLAYA LIVING

CARATTERISTICHE TECNICHE

- > Rivestimento interno vasca in fibre poliesteri e polimeri ad alta resistenza e durata.
- > Struttura in acciaio inox (lato skimmer) e acciaio zinco magnesio S250GD ZM310 verniciato a polvere (ZMSV-TEC).



DOTAZIONI DI SERIE

- > Impianto di filtrazione e trattamento acqua esclusivo Laghetto
- > Faretto a Led

ACCESSORI

- > Cuscino Playa in sky nautico.
Varianti: natural, brown, grey, water.
- > Cuscini Living in Sky nautico.
Varianti: natural, brown, grey, water.
- > Riscaldamento dell'acqua
- > Massaggio ad aria con bolle
- > Telo di copertura

FINITURE ESTETICHE

- > Rivestimento esterno integrale in fibra sintetica intrecciata a mano su telaio di alluminio verniciato.
Varianti: Laghetto white, grey, coffee.*



TECHNICAL FEATURES

- > High strength liner in durable polyester and polymer.
- > Structure made of stainless steel (skimmer side) and zinc magnesium steel S250GD ZM310 powder coated (ZSMV-TEC).

EQUIPMENT

- > Laghetto exclusive filtration system and water treatment.
- > LED spot light.

ACCESSORIES

- > Playa cushion: Nautical Sky fabric finish. Colors: natural, brown, grey, water.
- > Nautical Sky fabric finish Living cushions. Colors: natural, brown, grey, water.
- > Water heating.
- > Air massage with bubbles.
- > Cover.

AESTHETIC FINISHES

- > Wicker exterior panels on aluminum frame.
Colors: Laghetto white, grey, coffee.*

CARACTERISTIQUES TECHNIQUES

- > Revêtement intérieur du bassin en fibres de polyester et polymères à haute résistance et longévité.
- > Structure en inox (côté skimmer) et acier zinc-magnésium S250GD ZM310 recouverte de peinture à poudre (ZSMV-TEC).

EQUIPEMENT

- > Système de filtration et de traitement de l'eau exclusifs Laghetto.
- > Projecteur à Led.

ACCESSOIRES

- > Coussins Playa en tissus Sky nautique. Couleurs: natural, brown, grey, water.
- > Coussins Living en tissus Sky nautique. Couleurs: natural, brown, grey, water.
- > Réchauffeur.
- > Système d'hydromassage par air.
- > Couverture de protection.

FINITIONS ESTHETIQUES

- > Panneaux extérieurs en fibre synthétique tressée, sur châssis en aluminium. Couleurs: Laghetto white, grey, coffee.*

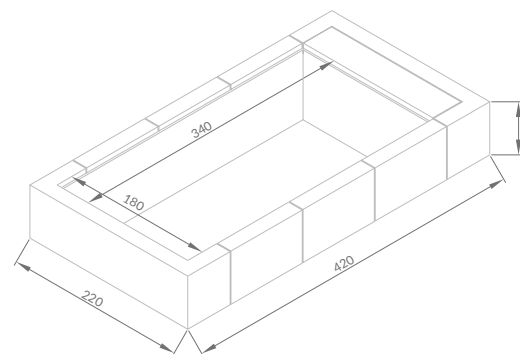
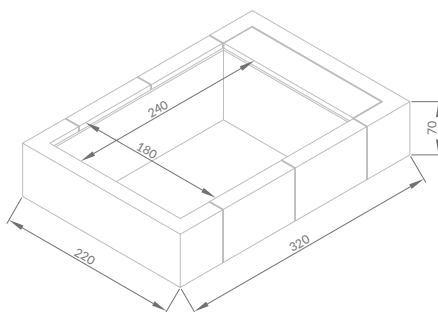
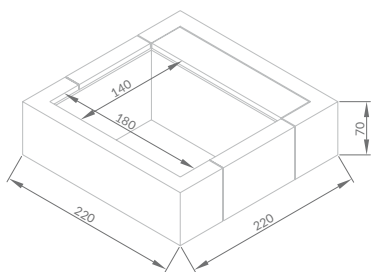

PLAYA

PLAYA LIVING

MOD.	SPECCHIO D'ACQUA water size miroir d'eau (m)	INGOMBRO TOTALE total encumbrance encombrement totale (m)	ALTEZZA ACQUA water height hauteur de l'eau (cm)	ALTEZZA TOTALE total height hauteur totale (cm)	VOLUME (l)
PLAYA 1	1,4 x 1,80	2,20 x 2,20	55	70	1200
PLAYA 2	2,40 x 1,80	3,20 x 2,20	55	70	2000
PLAYA 3	3,40 x 1,80	4,20 x 2,20	55	70	3000

the measures are indicative dimensions indicatives
mesure indicative (non vinculanti)

VERSIONI DISPONIBILI AVAILABLE VERSIONS VERSIONS DISPONIBLES

MOD.	MINIPISCINA Mini-pool Mini-piscine	COLORI DISPONIBILI available colours coloris disponibles	RISCALDATORE E BOLLE Heater and bubbles Balneo	COLORI DISPONIBILI available colours coloris disponibles
PLAYA 1				
PLAYA 2				
PLAYA 3	not available	not available		

ATTENZIONE: Il prodotto è destinato esclusivamente ad uso privato. WARNING: The product is for private use only. AVERTISSEMENT : Ce produit est destiné à un usage privé uniquement.
***ATTENZIONE: Le gradazioni di colore potrebbero subire variazioni.** ATTENTION: Colour shades may vary. ATTENTION : Les nuances de couleurs peuvent varier.

PLAYA

5 ^{1/2} *years*
WARRANTY

GARANZIA PISCINA: 5 ANNI
POOL WARRANTY: 5 YEARS | GARANTIE BASSIN: 5 ANS
GARANZIA ACCESSORI: 2 ANNI
ACCESSORIES WARRANTY: 2 YEARS | GARANTIE ACCESSOIRES: 2 ANS

Designed and made in Italy.

Friendly materials according to the European standards of safety and non-toxicity.

Laghetto quality, leader for 40 years.

pool design

2022
NEWS



il tuo specchio d'acqua / your own pool

PLAYA *Twin*

PISCINE
LAGHETTO®

PLAYA *Twin*

DOPPIO RELAX A BORDO ACQUA



Playa Twin è una vera spiaggia accessoriata, che raddoppia lo spazio per rilassarsi al sole a bordo vasca.

È completa di due esclusivi lettini di serie in coordinato, con schienale reclinabile e piedi pieghevoli, ideali per il relax ma progettati anche per diventare la copertura perfetta dello specchio d'acqua.

Playa Twin è proposta nella versione con Riscaldatore e Bolle e può essere accessoriata con la cuciniera in coordinato.

DOUBLE RELAX AT THE WATERSIDE

Playa Twin is a true equipped beach, which doubles the space for relaxing in the sun by the pool.

It is complete with two exclusive matching standard sunbeds, with reclining backrest and folding feet, ideal for relaxation but also designed to become the perfect cover for the water mirror.

Playa Twin is proposed in the version with heater and bubbles and can be equipped with coordinated cushions.

2 ESPACES DE DÉTENTE AU BORD DE L'EAU

Playa Twin a été pensée comme une plage au bord de l'eau sur laquelle 2 espaces de détente sont proposés.

En complément des 2 baignoires, viennent s'ajouter 2 transats dans la finition fibre synthétique tressée pour une parfaite harmonie. Le confort est accentué par un dossier inclinable et les pieds se replient pour devenir une protection du bassin.

Playa Twin est disponible en version balnéothérapie avec réchauffeur et hydromassage.

Tout comme pour le modèle PLAYA, les coussins de couleur finissent l'habillement.



Sistemi di filtraggio e **trattamento acqua** esclusivo Laghetto

Laghetto exclusive **filtration system** and water treatment

Systèmes de filtration et de traitement de l'eau exclusifs Laghetto

Centralina con riscaldatore e sistema massaggio a bolle.

Control unit with heater and bubble massage system.

Unité de contrôle avec chauffage et système d'hydromassage.

Faretto a Led ad alta resa luminosa

LED spotlight high brightness spotlight

Projecteur à Led luminosité intense

Struttura interna
Internal structure
Structure intérieure



N. 2 lettini Relax con testata inclinabile e gambe pieghevoli.

N. 2 Relax sun loungers with tilting headboard and foldable legs.

N. 2 bain de soleil Relax avec dossier réglable et pieds repliables.

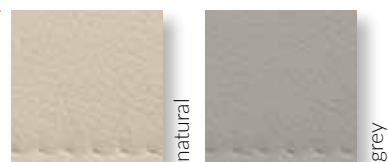

Cuscino Playa Twin

Rivestimento in tessuto Sky nautico

Playa Twin cushion

Nautical Sky fabric finish.

Coussin Playa Twin

Revêtu de tissu Sky nautique.



Rivestimento interno
Liner
Revêtement intérieur

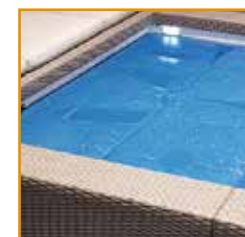

Telo isothermico incluso
Isothermic cover
Couverture isothermique



Laghetto white*

Pannelli esterni
fibra sintetica
intrecciata

Exterior panels
handwoven fiber



grey*

Panneaux extérieurs
Fibre synthétique tressée

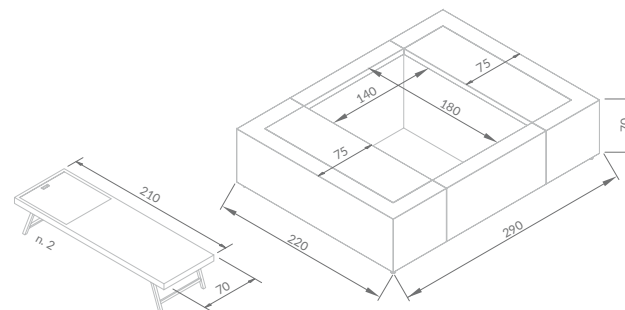

5/^e years **WARRANTY**

GARANZIA PISCINA: 5 ANNI POOL WARRANTY: 5 YEARS | **GARANTIE BASSIN: 5 ANS**

GARANZIA ACCESSORI: 2 ANNI ACCESSORIES WARRANTY: 2 YEARS | **GARANTIE ACCESSOIRES: 2 ANS**

MOD.	SPECCHIO D'ACQUA (m) water size miroir d'eau	INGOMBRO TOTALE (m) total encumbrance encombrement total	ALTEZZA ACQUA (cm) water height hauteur de l'eau	ALTEZZA TOTALE (cm) total height hauteur totale	VOLUME (l)
PLAYA TWIN	1,4 x 1,80	2,20 x 2,90	55	70	1200

measure indicative (non vincolanti)
the measures are indicatives
dimensions indicatives

pool design



il tuo specchio d'acqua / your own pool

Dolce Vita

PISCINE
LAGHETTO®



ELEGANZA E TECNOLOGIA

DolceVita rinnova il mondo delle piscine fuori terra grazie alla solida tecnologia Laghetto presente sul mercato da più di 40 anni e al suo design elegante e innovativo.

DolceVita sa adattarsi ai bisogni di una famiglia che cambia, consentendo ripensamenti, spostamenti e traslochi.

La sua versatilità permette un montaggio facile e veloce anche in zone con permessi di utilizzo solo stagionale.

DolceVita fornisce un sistema di ricircolo e filtrazione che consente la massima qualità dell'igiene e della purezza dell'acqua.

DolceVita si presenta in tre modelli: Diva, Diva LTI e Rattan, con materiali di altissima qualità che ne garantiscono l'uso nel tempo.

ELEGANCE AND TECHNOLOGY

DolceVita renews the world of above-ground pools thanks to a sound technology Laghetto which is on the market for over 40 years, and its innovative and graceful design.

DolceVita can adapt to the needs of a changing family, allowing thoughts, repositioning and moving.

Its versatility allows easy and quick installation even in areas with seasonal permits only.

DolceVita provides a recirculating and filtration system which enables the highest quality and hygiene of the water purity.

DolceVita comes up in three different models: Diva, Diva LTI and Rattan, with high quality materials that ensure long time use.

ELEGANCE ET TECHNOLOGIE

DolceVita renouvèle le monde des piscines hors-sol grâce à sa technologie Laghetto, qui est sur le marché depuis plus de 40 ans, et grâce à son design élégant et innovateur.

DolceVita peut s'adapter aux besoins d'une famille qui change, en permettant de se raviser et de se déplacer.

Adaptable mais également grâce à un montage facile & rapide, DolceVita répond parfaitement aux contraintes de saisonnalité dans des zones où seule la pose de structure temporaire est autorisée.

Prête à utiliser, DolceVita est équipée d'un système complet de filtration pour un traitement optimal de l'eau.

La gamme DolceVita se décline en trois modèles: Diva, Diva LTI et Rattan. Conçus avec des matériaux haut de gamme, ils assurent une longévité d'utilisation.





DIVA - Laghetto white



DIVA
Laghetto white

Dolce Vita

PISCINE **LAGHETTO**[®]



DIVA
Grey

Dolce Vita

PISCINE LAGHETTO®



DIVA - Grey



DIVA - Grey



DIVA
Laghetto white

Dolce Vita

PISCINE **LAGHETTO**[®]



DIVA LTI - Grey



DIVA LTI
Laghetto white

Dolce Vita

PISCINE LAGHETTO®



RATTAN
Coffee



RATTAN - *Coffee*



RATTAN - Grey



RATTAN
Grey

Dolce Vita

PISCINE LAGHETTO®

Dolce Vita

CARATTERISTICHE TECNICHE

Rivestimento interno vasca in fibre poliestere e polimeri ad alta resistenza e durata.

Struttura in acciaio inox e parti in acciaio zinco magnesio. Tecnologia ZMSV-TEC.



DOTAZIONI DI SERIE

- > Impianto di filtrazione e trattamento acqua esclusivo Laghetto
- > Faretti a Led
- > Scala di accesso

ACCESSORI

- > Basamento per il montaggio direttamente sul terreno senza opere edili
- > Kit idromassaggio a 7 getti
- > Sistema nuoto contro-corrente
- > Copripiscina invernali ed estivi termici
- > Pompa di calore per riscaldamento acqua

COLLEZIONI FINITURE ESTETICHE

DIVA - DIVA LTI

- > Rivestimento esterno integrale in fibra sintetica intrecciata a mano su telaio di alluminio verniciato.

RATTAN

- > Rivestimento esterno in pannelli di fibra sintetica intrecciata a mano su telaio di alluminio verniciato. Bordo in eco-legno.

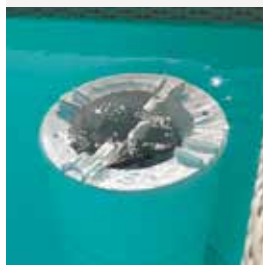

TECHNICAL CHARACTERISTICS

High strength liner in durable polyester and polymer.
Stainless steel structure and zinc magnesium steel parts.
ZMSV-TEC technology.

EQUIPMENT

- > Laghetto exclusive filtration system and water treatment.
- > LED spot light
- > Ladder

ACCESSORIES

- > Base kit for direct assembly onto the ground
- > 7 jets hydromassage kit
- > Swim jet system
- > Pool debris cover and solar cover
- > Heat pump

FINISHES

- DIVA - DIVA LTI** Wicker exterior pannels on aluminum frame.
- RATTAN** Wicker exterior pannels on aluminum frame.
Eco-wood top edge.

CARACTERISTIQUES TECHNIQUES

Revêtement intérieur du bassin en fibre de polyester et polymères à haute résistance et longévité.
Structure en acier inoxydable et pièces en acier au zinc-magnésium.
Technologie ZMSV-TEC.

EQUIPEMENT

- > Systèmes de filtration et de traitement exclusifs Laghetto
- > Projecteur à Led
- > Échelle

ACCESSOIRES

- > Embase pour montage au sol
- > Kit d'hydromassage à 7 jets
- > Nage à contre-courant
- > Couverture solaire et d'hivernage
- > Pompe à chaleur

FINITIONS ESTHETIQUES DE CHAQUE COLLECTION

- DIVA - DIVA LTI** Panneaux extérieurs en fibre synthétique tressée avec bordure intégrée.
- RATTAN** Panneaux extérieurs en fibre synthétique tressée et margelles en bois composite Eco-Wood.

DIVA LTI - CARATTERISTICHE

characteristics | caractéristiques

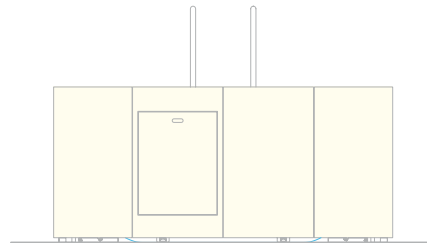
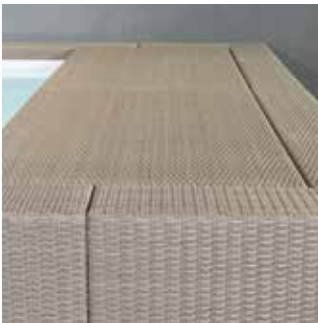

Vano tecnico a bordo vasca per piscine Dolcevita Diva con larghezza specchio d'acqua 3 - 4 m.

Technical compartment by the pool for Dolcevita Diva with water size width 3 - 4 m

Compartment technique au bord du bassin pour piscines Dolcevita Diva avec largeur du miroir d'eau 3 - 4 m

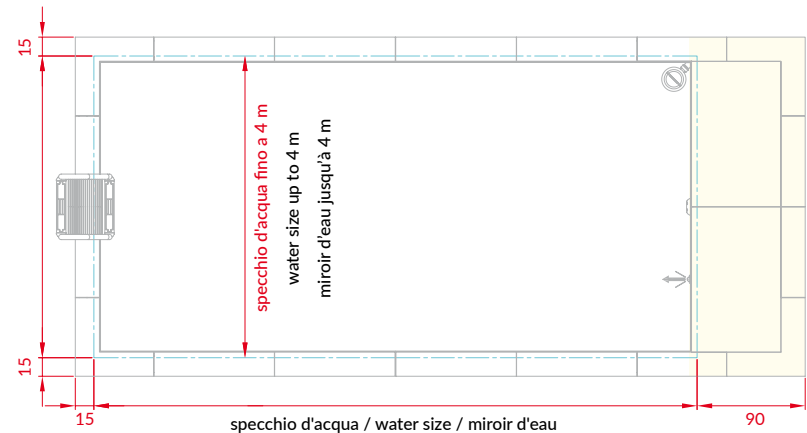

BASAMENTO PER MONTAGGIO SU TERRA SENZA OPERE EDILI

base | basement



Dolcevita è montabile e smontabile facilmente in poche ore e può essere installata anche ad uso solo stagionale.



Dolcevita can easily be assembled or disassembled in few hours and used on a seasonal basis.

Dolcevita se monte et se démonte rapidement et aisément. La piscine hors sol peut donc ainsi être installée de façon temporaire.

COLORI RIVESTIMENTO INTERNO	liner colours	Coloris du revêtement intérieur
	 white	 beige
DIVA - DIVA LTI	■	■
RATTAN	■	■

PANNELLI	panels	panneaux d'habillage	
	 Laghetto white*	 grey*	 coffee*
DIVA - DIVA LTI	■	■	■
RATTAN	■	■	■

*ATTENZIONE: Le gradazioni di colore potrebbero subire variazioni. ATTENTION: Colour shades may vary. ATTENTION : Les nuances de couleurs peuvent varier.

BORDO	coping	margelles	
	 eco-wood tabacco	 eco-wood ardesia	 synthetic fiber
DIVA - DIVA LTI	■	■	■
RATTAN	■	■	■

MOD.	SPECCHIO D'ACQUA (m) water size miroir d'eau	INGOMBRO TOTALE (m) total encumbrance encombrement total	ALTEZZA ACQUA (m) water height hauteur de l'eau	ALTEZZA TOTALE (m) total height hauteur totale	VOLUME (mc)
DIVA - RATTAN					
24	2 x 4	2,4 x 4,4	1,2	1,3	9,6
25	2 x 5	2,4 x 5,4	1,2	1,3	12
35	3 x 5	3,4 x 5,4	1,2	1,3	18
36	3 x 6	3,4 x 6,4	1,2	1,3	21,6
37	3 x 7	3,4 x 7,4	1,2	1,3	25,2
48	4 x 8	4,4 x 8,4	1,2	1,3	38,4
49	4 x 9	4,4 x 9,4	1,2	1,3	43,2
510	5 x 10	5,4 x 10,4	1,2	1,3	60

DIVA LTI					
35	3 x 5	3,4 x 6,1	1,2	1,3	18
36	3 x 6	3,4 x 7,1	1,2	1,3	21,6
37	3 x 7	3,4 x 8,1	1,2	1,3	25,2
48	4 x 8	4,4 x 9,1	1,2	1,3	38,4
49	4 x 9	4,4 x 10,10	1,2	1,3	43,2

misure indicative (non vincolanti) | the measures are indicatives | dimensions indicatives

Dolce Vita

5 | **2** years
WARRANTY

GARANZIA PISCINA: 5 ANNI
 POOL WARRANTY: 5 YEARS | GARANTIE BASSIN: 5 ANS
GARANZIA ACCESSORI: 2 ANNI
 ACCESSORIES WARRANTY: 2 YEARS | GARANTIE ACCESSOIRES: 2 ANS

Designed and made in Italy.

Friendly materials according to the European standards of safety and non-toxicity.

Laghetto quality, leader for 40 years.



vo^tre miroir d'eau
il tuo specchio d'acqua
your own pool

POOL DESIGN

Divina

PISCINE **LAGHETTO**®

Divina

Divina, ultima nata della gamma DolceVita, esprime già dal nome quello stile e fascino che la contraddistinguono: espressione contemporanea della piscina come complemento d'arredo di classe per gli spazi aperti, momento per godere il relax e la bellezza del tuo giardino.

La sua vasca seminterrata è avvolta con pannelli dalla piacevole finitura in rattan sintetico, intrecciato a mano su telaio di alluminio verniciato; impreziosita dal lettino prendisole con morbidi cuscini in Sky nautico, offre il massimo relax mentre ti rilassi al sole a fianco del tuo specchio d'acqua.

SEMINTERRATA

Divina coniuga le esigenze di stile ed eleganza alla voglia di divertimento di tutta la famiglia, potendo essere accessoriata come una piscina tradizionale: faretto a Led, nuoto contro corrente e riscaldatore, che permette di godere il piacere della piscina più a lungo.

Due varianti di colore per il rivestimento in rattan, la possibilità di aggiungere una zona living coordinata e l'ampia gamma di misure rendono unica ogni vasca Divina.

Dotata di locale tecnico sotto la zona prendisole, si installa senza opere edili impattanti ed in pochissimi giorni, garantendoti di godere al massimo il tuo spazio esterno.

CONTEMPORARY SEMI-UNDERGROUND

Divina, the latest addition to the DolceVita range, already expresses from its name the style and charm that distinguish it: contemporary expression of the swimming pool as a classy furnishing accessory for open spaces, a moment to enjoy the relaxation and beauty of your garden.

Its semi-underground basin is wrapped in panels with a pleasant synthetic rattan finish, hand woven on a painted aluminium frame; embellished with a sunbed and seats with soft cushions in nautical Sky, it offers maximum relaxation while you relax in the sun next to your mirror of water.

Divina combines the needs of style and elegance with the desire of the whole family to have fun, as it can be equipped like a traditional swimming pool: LED spotlights, swimming against the current and heater, which allows you to enjoy the pleasure of the pool for longer.

Two colour variations for the rattan coverings, the possibility of adding a coordinated living and the wide range of sizes make each Divina pool unique.

Equipped with a technical room under the sunbathing area, it can be installed without impacting construction works and in just a few days, ensuring that you can enjoy your outdoor space to the full.

CONTEMPORANEA

SEMI-ENTERRÉE CONTEMPORAINE

Lorsque la belle lame d'eau se confond avec la couleur du ciel & qu'elle valorise son charme qui le distinguent : l'expression contemporaine de la piscine comme accessoire d'ameublement de classe pour les espaces ouverts, un moment pour profiter de la détente et de la beauté de votre jardin.

Sa cuve semi-enterrée est enveloppée de panneaux au fini agréable en rattan synthétique, tissés à la main sur un cadre en aluminium verni. Agrémentée d'un bain de soleil et de sièges aux coussins souples en Sky nautique, elle offre une détente maximale pendant que vous vous relaxez au soleil à côté de votre plan d'eau.

Divina combine les besoins de style et d'élégance avec le désir de toute la famille de s'amuser, car elle peut être équipée comme une piscine traditionnelle: spots LED, nage à contre-courant et chauffage, ce qui permet de profiter plus longtemps du plaisir de la piscine.

Deux variations de couleurs pour le revêtement en rattan, la possibilité d'ajouter un espace living coordonné et le large éventail de tailles font de chaque piscine Divina une pièce unique.

Doté d'un local technique sous la zone solarium, il peut être installé sans incidence sur les travaux de construction et en quelques jours seulement, vous permettant ainsi de profiter pleinement de votre espace extérieur.









DIVINA: IL PIACERE DELL'ACQUA SI VESTE DI ELEGANZA

| the pleasure of water is dressed in elegance

| le plaisir de l'eau s'associe à l'élégance

Divina

PISCINE LAGHETTO®



DIVINA: RAFFINATI INTRECCI
refined woven textures | un tissage raffiné

Divina

PISCINE LAGHETTO®







DIVINA: LA PERFEZIONE DELLE FORME
the perfection of shapes | la perfection des formes

Divina

PISCINE LAGHETTO®

VERSIONE MONTAGGIO SU SOLETTA IN C.A.

Version for assembly on concrete base

Version montage sur une dalle en béton armé

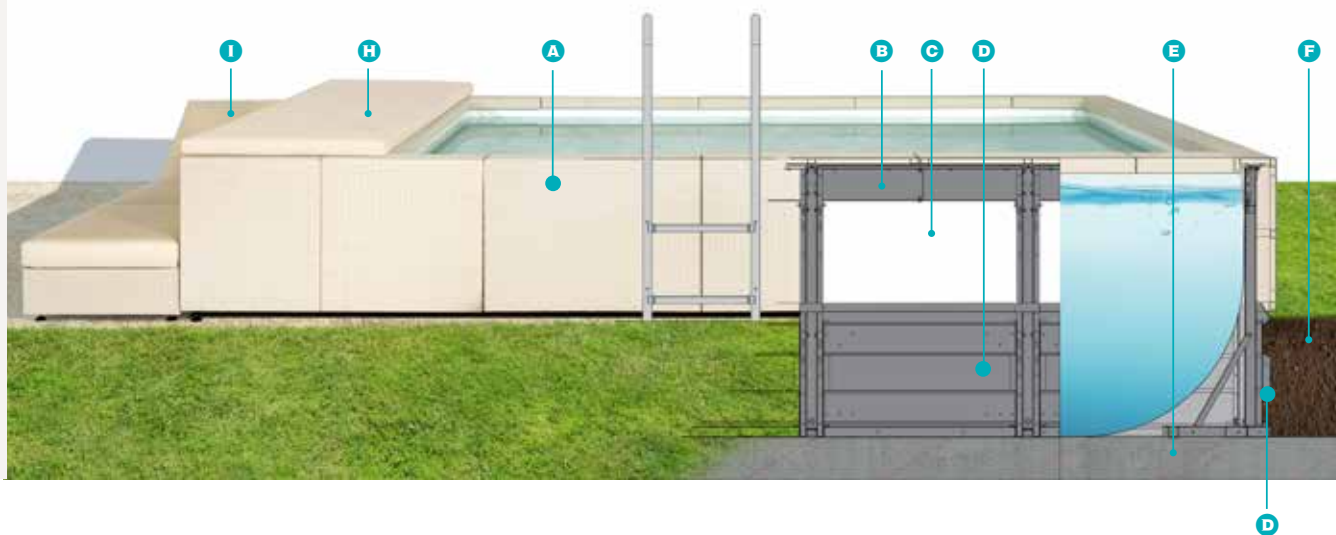

VERSIONE MONTAGGIO SU TERRA

Version for assembly on the ground

Version pour montage au sol

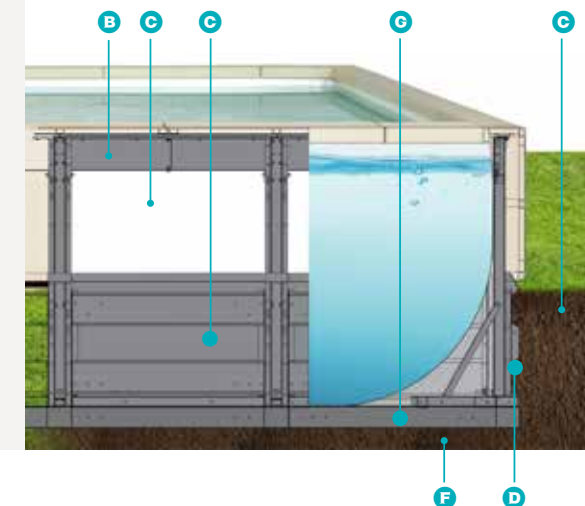

Divina

- A Pannello estetico in fibra sintetica intrecciata a mano su telaio di alluminio verniciato.**
Synthetic rattan panel, hand-woven on chassis, in varnished aluminum
Meuble en rattan synthétique tressé à la main sur chassis en aluminium vernis
- B Struttura piscina.** Pool structure. Structure piscine.
- C Telo vasca.** Pool liner. Toile piscine.
- D Pannello contenimento terra.**
Ground containment panel.
Parois de confinement du sol.
- E Basamento in cemento armato.**
Reinforced concrete base.
Embase en béton armé.
- F Terra.** Ground. Sol.
- G Kit basamento per il montaggio su terra senza utilizzo cemento.**
Base kit for direct assembly onto the ground, without concrete base.
Embase pour montage direct au sol, sans embase en béton.
- H Cuscini Divina** Divina cushions. Coussins Divina.
- I Elementi di seduta Living con cuscini (optional).**
Seats with cushions - Living (optional).
Sièges avec coussins - Living (optionnels).

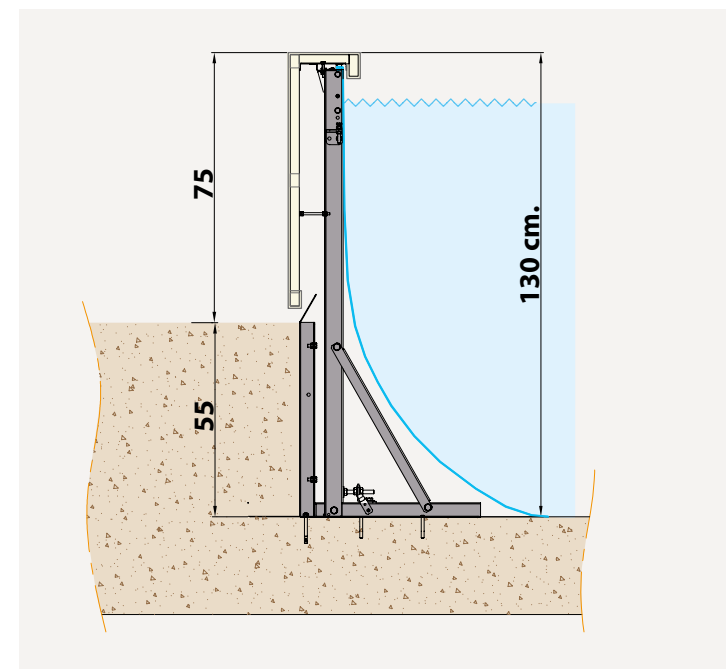

Divina

CARATTERISTICHE TECNICHE

Rivestimento interno vasca in fibre poliesteri e polimeri ad alta resistenza e durata.

Struttura in acciaio inox e parti in acciaio zinco magnesio. Tecnologia ZMSV-TEC.



DOTAZIONI DI SERIE

- > Impianto di filtrazione e trattamento acqua esclusivo Laghetto.
- > Faretto a Led.
- > Scala di accesso.
- > Locale tecnico integrato nella zona prendisole con sportello di accesso.
- > Kit pannelli struttura per interro.
- > Basamento per il montaggio direttamente sul terreno senza opere edili.
- > Cuscini Divina sopra il locale tecnico

ACCESSORI

- > Copripiscina invernali ed estivi termici
- > Elementi di seduta con cuscini (Living).

FINITURA ESTETICA

- > Rivestimento esterno integrale in fibra sintetica intrecciata a mano su telaio di alluminio verniciato.

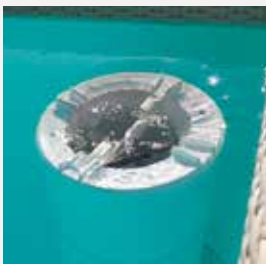

TECHNICAL CHARACTERISTICS

High strength liner in durable polyester and polymer.

Stainless steel structure and zinc magnesium steel parts. ZMSV-TEC technology.

EQUIPMENT

- > Laghetto exclusive filtration system and water treatment.
- > LED spot light.
- > Ladder.
- > Technical compartment integrated into the pool sunbathing area, with access door.
- > Inground structure panels.
- > Base kit for direct assembly onto the ground.
- > Divina cushions above the technical compartment.

ACCESSORIES

- > Pool debris cover and solar cover.
- > Seats with cushions (Living).

AESTHETIC FINISHES

- > Wicker exterior panels on aluminium frame.

CARACTERISTIQUES TECHNIQUES

Revêtement intérieur du bassin en fibre de polyester et polymères à haute résistance et longévité.

Structure en acier inoxydable et pièces en acier au zinc et au magnésium. Technologie ZMSV-TEC.

EQUIPEMENT

- > Systèmes de filtration et de traitement exclusifs Laghetto
- > Projecteur à Led.
- > Échelle.
- > Compartiment technique intégré à la zone bain de soleil, avec porte d'accès.
- > Panneaux structure enterrée.
- > Embase pour montage au sol.
- > Coussins Divina au-dessus du compartiment technique.

ACCESSOIRES

- > Couverture solaire et d'hivernage.
- > Sièges avec coussins (Living).

FINITIONS ESTHETIQUES

- > Panneaux extérieurs en fibre synthétique tressée sur châssis en aluminium.

COLORI DISPONIBILI | AVAILABLE COLORS | COLORIS DISPONIBLES



Fibra sintetica intrecciata

Handwoven fiber | Fibre synthétique tressée



Laghetto white



grey

Rivestimento interno

Liner | Revêtement intérieur



white



beige

Cuscineria in tessuto Sky nautico

Nautical Sky fabric cushions | Coussins en tissu Sky nautique



natural



DOLCEVITA - DIVINA

MOD.	SPECCHIO D'ACQUA (m) water size miroir d'eau	INGOMBRO TOTALE (m) total encumbrance encombrement total	ALTEZZA ACQUA (m) water height hauteur de l'eau	ALTEZZA TOTALE (m) total height hauteur totale	VOLUME (m ³)
35	3 x 5	3,4 x 6,1	1,2	1,3	18
36	3 x 6	3,4 x 7,1	1,2	1,3	21,6
37	3 x 7	3,4 x 8,1	1,2	1,3	25,2
48	4 x 8	4,4 x 9,1	1,2	1,3	38,4

Divina

5 1/2 years
WARRANTY

GARANZIA PISCINA: 5 ANNI
POOL WARRANTY: 5 YEARS | GARANTIE BASSIN: 5 ANS
GARANZIA ACCESSORI: 2 ANNI
ACCESSORIES WARRANTY: 2 YEARS | GARANTIE ACCESSOIRES: 2 ANS

Designed and made in Italy.

Friendly materials according to the European standards of safety and non-toxicity.

Laghetto quality, leader for 40 years.



POOL DESIGN

votre miroir d'eau
il tuo specchio d'acqua
your own pool

INFINITY *Divina*

PISCINE **LAGHETTO**[®]

INFINITY *Divina*

ARTE IN GIARDINO

INFINITY Divina, valorizza il tuo spazio esterno con un tocco distintivo e unico, che coinvolge e solletica i tuoi sensi.

Infinity è la piscina seminterrata dalle linee moderne e dallo stile inconfondibilmente elegante, semplice e di grande classe, impreziosito dai raffinati intrecci del rattan sintetico, morbidi e piacevoli al tatto, che nascondono il cuore tecnologico del sistema di tracimazione a sfioro.

Infinity coinvolge tutti i tuoi sensi con il suono rilassante dell'acqua che scompare sotto il bordo, l'eleganza delle forme che appagano la vista, il confort di una morbida e accogliente area prendisole che circonda l'intera vasca ed il piacere di immergersi in una piscina unica ed iconica. Per una soluzione ancora più esclusiva, Infinity può anche essere completata ed arricchita con tutti gli elementi di seduta Living Piscine Laghetto.



ART IN THE GARDEN > L'ART DANS LE JARDIN

INFINITY Divina, upgrades your outdoor space with a distinctive and unique touch that involves and tickles your senses.

Infinity is the semi-inground swimming pool with modern lines and distinctively elegant style, simple and classy, enhanced by the refined twine of synthetic rattan, soft and pleasant to touch, hiding the technological heart of the overflow system.

Infinity involves all your senses with the relaxing sound of water disappearing under the edge, the elegance of shapes that please the eye, the comfort of a soft and welcoming sunbathing area that surrounds the entire pool and the pleasure of dive yourself in a unique and iconic pool.

For an even more exclusive solution, Infinity can also be completed and enriched with all the Living Piscine Laghetto seating elements.

INFINITY Divina, sublimez votre espace extérieur avec une touche distinctive et unique qui éveille et chatouille vos sens.

Infinity est la piscine semi-enterrée aux lignes modernes et au style indéniablement élégant, simple et classe, mis en valeur par les tissages raffinés du rotin synthétique, doux et agréable au toucher, qui dissimulent le cœur technologique du système de débordement.

Infinity fait appel à tous vos sens avec le son relaxant de l'eau qui disparaît sous le bord, l'élégance des formes qui plaisent à l'œil, le confort d'une zone de bronzage douce et accueillante qui entoure toute la piscine et le plaisir de s'immerger dans une piscine unique et emblématique.

Pour une solution encore plus exclusive, Infinity peut également être complétée et enrichie de tous les éléments d'assise Living Piscine Laghetto.

INFINITY *Divina*

CARATTERISTICHE TECNICHE

Rivestimento interno vasca e canalina di sfioro in fibre poliesteri e polimeri ad alta resistenza e durata.

Struttura vasca con pannelli per montaggio su basamento in C.A.

Struttura in acciaio inox e parti in acciaio zinco magnesio. Tecnologia ZMSV-TEC.



DOTAZIONI DI SERIE

- > Sistema di filtrazione a sfioro e trattamento acqua esclusivo Laghetto.
- > Faretti a Led.
- > Scala di accesso.
- > Locale tecnico integrato nella zona prendisole con sportello di accesso.
- > Cuscini Infinity Divina sopra il locale tecnico

ACCESSORI

- > Copripiscina invernali ed estivi termici
- > Piscina abbinabile agli elementi di seduta Living

FINITURA ESTETICA

- > Rivestimento esterno integrale in fibra sintetica intrecciata a mano su telaio di alluminio verniciato.



TECHNICAL CHARACTERISTICS

High strength liner and overflow channel in durable polyester and polymer. Pool structure with panels for assembly on reinforced concrete base. Stainless steel structure and zinc magnesium steel parts. ZMSV-TEC technology.

EQUIPMENT

- > Laghetto exclusive overflow filtration system and water treatment.
- > LED spot light.
- > Ladder.
- > Technical compartment integrated into the pool sunbathing area, with access door.
- > Infinity Divina cushions above the technical compartment.

ACCESSORIES

- > winter and summer thermal pool cover.
- > Pool matching with Living seating elements.

AESTHETIC FINISHES

- > Wicker exterior panels on aluminium frame.

CARACTERISTIQUES TECHNIQUES

Revêtement intérieur du bassin et canal de débordement en fibre de polyester et polymères à haute résistance et longévité.

Structure de piscine avec panneaux à monter sur une base en béton armé. Structure en acier inoxydable et pièces en acier au zinc et au magnésium. Technologie ZMSV-TEC.

EQUIPEMENT

- > Système de filtration par débordement et traitement exclusif de l'eau Laghetto.
- > Projecteur à Led.
- > Échelle.
- > Compartiment technique intégré à la zone bain de soleil, avec porte d'accès.
- > Coussins Infinity Divina au-dessus du compartiment technique.

ACCESSOIRES

- > Couverture solaire et d'hivernage.
- > Piscine assortie aux éléments d'assise Living

FINITIONS ESTHETIQUES

- > Panneaux extérieurs en fibre synthétique tressée sur châssis en aluminium.

5 ¹/₂ *years*
WARRANTY

GARANZIA PISCINA: 5 ANNI
POOL WARRANTY: 5 YEARS | GARANTIE BASSIN: 5 ANS

GARANZIA ACCESSORI: 2 ANNI
ACCESSORIES WARRANTY: 2 YEARS | GARANTIE ACCESSOIRES: 2 ANS

COLORI DISPONIBILI AVAILABLE COLORS COLORIS DISPONIBLES

Fibra sintetica intrecciata

Handwoven fiber | Fibre synthétique tressée



Laghetto white



grey

Rivestimento interno

Liner | Revêtement intérieur



white



beige

Cuscineria in tessuto Sky nautico

Nautical Sky fabric cushions | Coussins en tissu Sky nautique



natural



DIMENSIONI DISPONIBILI AVAILABLE SIZES DIMENSIONS DISPONIBLES

INFINITY DIVINA						
MOD.	SPECCHIO D'ACQUA (m) water size miroir d'eau	INGOMBRO TOTALE (m) total encumbrance encombrement total	ALTEZZA ACQUA (m) water height hauteur de l'eau	ALTEZZA TOTALE (m) total height hauteur totale	VOLUME (m ³)	
35	3 x 5	4,25 x 7,25	1,3	1,37	24	
36	3 x 6	4,25 x 8,25	1,3	1,37	28	
37	3 x 7	4,25 x 9,25	1,3	1,37	32	
48	4 x 8	5,25 x 10,25	1,3	1,37	47	

the measures are indicative dimensions indicatives
les mesures sont indicatives dimensions indicatives

**PISCINE
LAGHETTO®**

www.piscinelaghetto.com

Distribuito da:

FLUIDRA

Fluidra Commerciale Italia S.p.A. - via Tre Bocche, 7/G - 25081 Bedizzole (Bs) - Italia

FLUIDRA

© Copyright. All rights reserved. Pictures are not contractual. v.ITA 11.21

**PISCINE
LAGHETTO®**
a FLUIDRA company





votre miroir d'eau
il tuo specchio d'acqua
your own pool

Bluespring®

PISCINE **LAGHETTO**®

POOL DESIGN

Bluespring®

Quando i lati dello sfioro si fondono con il cielo e con l'atmosfera circostante, si realizza il compimento della piscina perfetta, il momento in cui la piscina scompare e si lega alle linee dell'infinito.

Elegante ed esclusiva, Bluespring è la piscina a sfioro adatta ad ogni esigenza: fare sport comodamente a casa, rilassarsi dopo il lavoro o concedersi del tempo con la famiglia, nella privacy della propria casa.

Lo sfioro perimetrale è il miglior sistema di filtrazione delle impurità galleggianti: l'acqua tracima dal bordo nel canale presente sotto la pavimentazione perimetrale ed entra nel sistema di filtraggio.

ALTA TECNOLOGIA

Col canale di tracimazione quindi non servirà più la di vasca di compenso esterna, interrata, ingombrante e costosa.

Tempi di realizzazione ridotti ed opere edili poco impattanti garantiscono uno spazio subito fruibile; la struttura autoportante si mantiene integra negli anni e permette manutenzioni e controllo semplici e veloci.

Bluespring: il massimo della tecnologia al servizio di chi crede nella bellezza del proprio specchio d'acqua.

HIGH-TECH, ENDLESS BEAUTY

When the sides of the overflow blend with the sky and with the surrounding atmosphere, the fulfillment of the perfect pool is realized, the time when the pool disappears and binds to the infinite lines.

Elegant and exclusive, Bluespring is the infinity pool suitable for every need: do sport comfortably at home, relax after work or enjoy time with the family, in the privacy of your own home.

The perimeter overflow is the best filtration system for floating impurities: the water overflows from the edge into the channel under the perimeter paving and enters the filtration system.

With the overflow channel, therefore, you will no longer need the external, underground, bulky and expensive compensation tank. Reduced construction times and low impact building works guarantee an immediately usable space; the self-supporting structure remains intact over the years and allows easy and quick maintenance and control.

The best technology at the service of demanding customers who believe in the beauty of their own water space.

BELLEZZA INFINITA

HAUTE TECHNOLOGIE, BEAUTÉ ÉTERNELLE

Lorsque la belle lame d'eau se confond avec la couleur du ciel & qu'elle valorise son environnement naturel alors, la piscine parfaite a été créée. Ce moment où la piscine disparaît pour se lier aux lignes de l'infini.

Élégante et exclusive, Bluespring est la piscine à débordement qui convient à tous les besoins : faire du sport confortablement chez soi, se détendre après le travail ou passer du temps en famille, dans l'intimité de sa maison.

Le débordement du périmètre est le meilleur système de filtration pour les impuretés en flottaison : l'eau se déverse dans le canal de débordement pour ensuite rejoindre le système de filtration. L'eau est aspirée depuis la goulotte périmétrique via un ou plusieurs collecteurs suivant les configurations (ajout d'options telles que Nage à Contre-Courant, Balnéo, Cascades) ou types d'utilisation (usage privé ou public). Avec ce système, plus besoin de bac tampon, encombrant et coûteux.

Bluespring est l'assurance d'une charge & d'un temps de travaux de construction réduits pour profiter rapidement de la piscine. Sa structure autoportante est durable pour une longévité accrue. Son entretien est simple, aucune maintenance longue & compliquée. Le meilleur de la technologie au service de l'esthétisme pour que la piscine soit le miroir d'eau de l'excellence.









BLUESPRING: COS'ALTRO? | whatelse? | quoi d'autre ?

Bluespring®

PISCINE LAGHETTO®



BLUESPRING: LA FORMA ESSENZIALE DELL'ACQUA
the essential shape of water | la forme essentielle de l'eau

Bluespring®

PISCINE LAGHETTO®









SCEGLI BLUESPRING: DIMENTICA IL RESTO

choose Bluespring: forget the rest | choisissez Bluespring : oubliez le reste !

Bluespring®

PISCINE **L'AGHETTO**®



BLUESPRING: IL TUO PERSONALE ANGOLO DI PARADISO
your own slice of paradise | votre coin de paradis

Bluespring®

PISCINE LAGHETTO®







BLUESPRING: PROFESSIONALI PER PASSIONE
professional for passion | professionnel par passion

Bluespring®

PISCINE LAGHETTO®





Bluespring®

CARATTERISTICHE TECNICHE

- › La struttura portante a due pareti in acciaio rivestito con l'innovativa protezione ZMSV-TECH (zinco-magnesio-vernice epossidica), appoggiata su piedi regolabili in altezza, assicura negli anni il perfetto livello di trascinamento su tutto il perimetro anche nel caso di parziale assestamento del terreno sottostante la vasca.
- › Bluespring può essere installata in tutti i contesti architettonici:
 - completamente o parzialmente interrata,
 - totalmente fuori terra,
 - fuori terra con uno o più lati contro collina nel caso di terreni terrazzati.
- › La parete contro acqua, distanziata da quella contro terra, garantisce una ottima coibentazione verso l'esterno, con notevoli risparmi energetici nel caso di riscaldamento dell'acqua.
- › Lo spazio libero tra le due pareti presente al di sotto del canale di trascinamento è sempre ispezionabile.
- › Questo permette di installare e verificare nel tempo il circuito idraulico perimetrale e gli accessori (es. nuoto controcorrente, faretti etc..).

TECHNICAL CHARACTERISTICS

- › Bluespring is constructed of a rigid supporting steel coated with innovative ZMSV-TECH (zinc-magnesium-epoxy coating) protection structure with adjustable feet, assuring a perfect overflow even if there is some ground settlement.
- › Bluespring can be installed on virtually any site. It can be in-ground, partially in-ground, above-ground and even installed on a terraced or sloping site.
- › There is a cavity between the pool wall and the outer wall giving excellent insulation and energy conservation.
- › The cavity between the two side walls, under the overflow channel, can be easily inspected, allowing the additional installation of new accessories at a later date (ie. Counter current swimming, lights...)

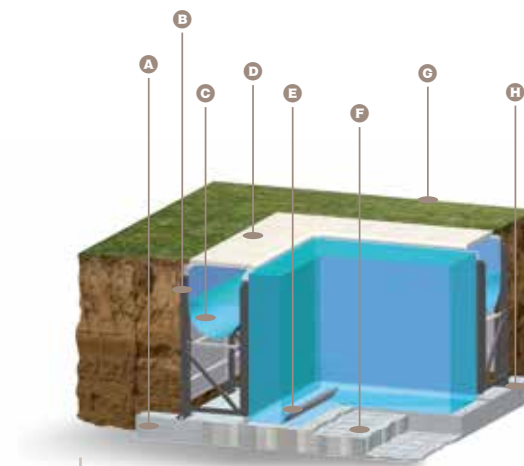

- A soletta in cemento armato** / Reinforced concrete base / Dalle en béton armé
- B struttura in acciaio** / Steel structure / Structure en acier
- C canalina di compensazione** / Overflow channel / Canal de compensation
- D pavimentazione perimetrale** / Copings / Margelles
- E membrana tecnica** / Liner / Revêtement armé
- F armatura del cemento** / Suitable cement / Armature de ciment
- G terrapieno** / Embankment / Terre plein
- H elementi di ancoraggio** / Anchor point / Eléments d'ancrage

CARACTERISTIQUES TECHNIQUES

- › La structure portante à deux parois en acier inoxydable revêtu d'une protection innovante ZMSV-TECH (peinture zinc-magnésium-époxy) appuyée sur des pieds réglables, assure longévité à la piscine. Débordement périmétrique durable et ce, même dans le cas d'un tassement d'une partie du terrain.
- › Le modèle Bluespring est conçu avec une structure en acier pour une intégration parfaite, quel que soit le choix de son implantation :
 - Enterrée ou semi-enterrée
 - Hors-sol
 - Hors-sol avec un ou plusieurs côtés adossés au décor environnant (terrains en terrasse, collines)
- › La conception de la double paroi offre une isolation thermique optimale. Ainsi, lorsque l'eau est chauffée par un système de pompe à chaleur, génère des économies énergétiques.
- › L'espace libre entre les deux parois, situé en dessous du débordement, permet un accès facile tout autour du bassin pour l'entretien des installations et l'ajout optionnel de nouveaux accessoires. (ex. nage à contre-courant, projecteurs, etc..)

ZMSV-TECH



ACCESSORI ACCESSORIES ACCESSOIRES

› **Sistema automatico di clorazione a sale**

Automatic salt chlorination system

Traitement automatique de l'eau par électrolyseur au sel

› **Copripiscina invernale**

Winter cover / Couverture d'hivernage

› **Copripiscina galleggiante termico**

Thermal floating pool cover / Couverture isothermique

› **Faretti a Led a luce bianca**

White LED lights / Projecteur à LED blancs

› **Nuoto contro-corrente a doppio getto**

Double jet counter current swimming system / Nage à contre-courant à double jet

› **Pompa di calore per riscaldamento a basso consumo**

Heat pump / Pompe à chaleur basse consommation

› **Angolo idromassaggio**

Spa corner / Espace hydromassage

COLORI DISPONIBILI AVAILABLE COLORS COLORIS DISPONIBLES

La tecnologia Bluespring permette ampia scelta di rivestimenti interni e di finiture di bordo anche personalizzabili.

The Bluespring technology allows a wide choice of liners and copings that can also be customised.

Bluespring propose une collection de revêtement avec un large choix de coloris & style. Personnalisation possible.



Bluespring®

20-2 years WARRANTY

GARANZIA PISCINA: 20 ANNI (DEGRESSIVA)
POOL WARRANTY: 20 YEARS | GARANTIE BASSIN: 20 ANS

GARANZIA ACCESSORI: 2 ANNI
ACCESSORIES WARRANTY: 2 YEARS | GARANTIE ACCESSOIRES: 2 ANS

Designed and made in Italy.

Friendly materials according to the European standards of safety and non-toxicity.

Laghetto quality, leader for 40 years.

PISCINE
LAGHETTO[®]

www.piscinelaghetto.com

Distribuito da:

FLUIDRA

Fluidra Commerciale Italia S.p.A. - via Tre Bocche, 7/G - 25081 Bedizzole (Bs) - Italia